



Unifin

A **Wabtec** company



Generator Cooling Products

The Hottest Name in Cooling for Large Electrical Power Equipment

Cooling Solutions

Generator Coolers



Unifin Hydrogen cooler
with platefin tubing



Unifin RCP™ cooler with
integral finned tubing



Unifin is a global leader in the supply of products used for cooling power generation equipment. With an extensive installation history and world renowned engineering capabilities Unifin offers a wide range of cooler expertise including:

- Generator Hydrogen Coolers
- Generator Air Coolers
- Stator Water Coolers
- Lube Oil Coolers
- Motor Air Coolers
- Bearing Oil Coolers
- Exciter Coolers
- Cooler Services
- Spare Parts



Fossil Fuel, Nuclear, Hydro-Electric and Combustion Turbine

As a supplier to the power utilities industry we thoroughly understand your requirements. Our manufacturing facilities are quality and compliance driven and we utilize ASME certified welders. We provide ASME Code construction and hold R, U and UM stamps.



Stator Water Coolers When Gas Cooling Alone is Not Enough

Large generators create more losses in the conducting components than can be safely removed through gas cooling on the exterior of these conductors. These large machines have Deionized (DI) water pass through the conducting bars to keep them cool. The heat rejected to the water needs to be removed externally from the generator by Unifin's Stator Water Cooler.



Hydrogen and Air Generator Coolers

Designed and Built for High Performance



Unifin is one of the world's leading suppliers of equipment used for cooling new and existing hydrogen- and air-cooled generator installations, including gas and steam turbines powered by combustion or nuclear technologies.

Electrical generators produce not only electricity but heat from electrical resistance ($I^2 \times R$) and windage losses that are a byproduct of creating electrical power from rotating equipment. Unifin coolers remove



this heat from the generator's cooling gas to the plant cooling water. Hydrogen and air coolers are an integral part of the overall heat removal system. Warm gas from the stator and rotor pass through the coolers, transferring heat to the fins and cooler tubes.

Known for their unmatched reliability, Unifin's generator coolers are designed and built to provide efficient power generation over the long haul.



Lube Oil Coolers

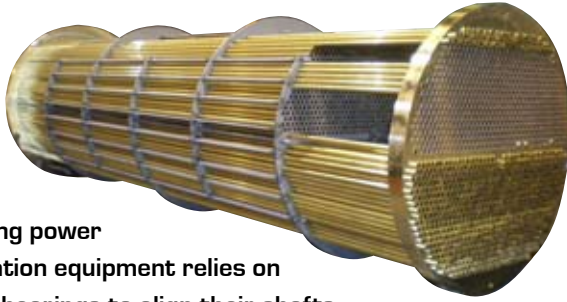

Rotating power generation equipment relies on sleeve bearings to align their shafts.

Heat, generated through friction, is picked up by the lubricating oil used in these bearings and needs to be removed. Unifin's Shell and Tube lube oil coolers offer just the right cooling solution.



Cleaning and maintenance are an important commitment to satisfactory cooler life. These units over time become fouled on the inside of the tubes as well as the exterior tube surfaces. Typically such coolers need to be refurbished or replaced after about 25 years of service depending on type of cooling water.

Bearing Oil Coolers

Hydro electric generators have thrust and guide bearings usually working in an oil bath. Coolers with extended spiral fins are installed in the oil bath to remove the heat generated by friction in the bearings. Unifin coolers have extremely long life and typically only need replacing after a period of 30 years or more. They are not typically cleanable or repairable and are replaced when they are no longer functional.

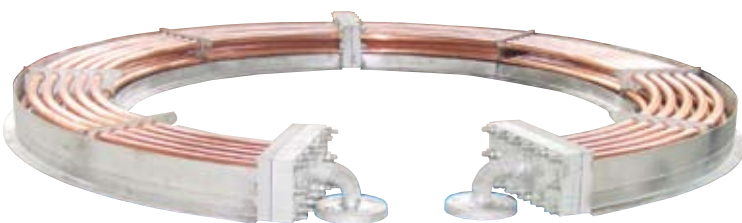

Exciter Air Coolers

... Cooling Your Other Generator

Large utility hydrogen-cooled generators sometimes require excitation power from an external source. This power is created from a small air-cooled generator which has its own system of cooling equipment. Unifin's coolers in the air-cooled generator range from a single cooler horizontal design to a multi cooler vertical mount design.

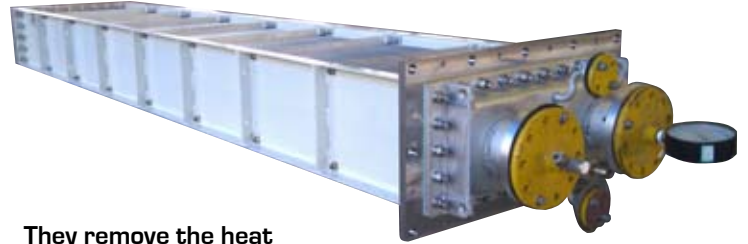

They remove the heat generated by electrical losses as well as frictional windage losses maintaining appropriate temperatures in the generator to protect insulation and integrity of the generator. They tend to become fouled on the tubeside and require periodic cleaning to maintain peak performance. These coolers, depending on age, may have the older spiral fin or may contain the newer platefin design. In most cases, when the coolers are replaced, it is more economical to replace with the platefin design.

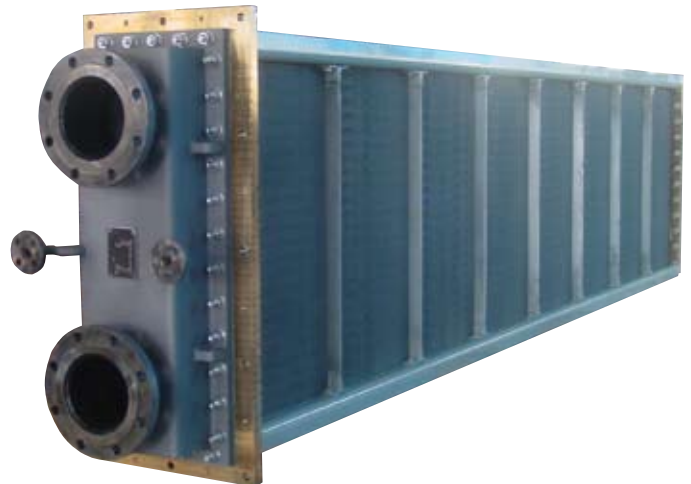

Marine and TEWAC Motor Coolers

Marine and Industrial TEWAC motor installations must be especially rugged to withstand shocks and corrosive environments. Unifin manufactures coolers specifically for these aggressive conditions. Unifin's unique leak detector configuration is a popular option.



Leak Detector

The leak detector system is designed to prevent catastrophic failure of the motor or generator should

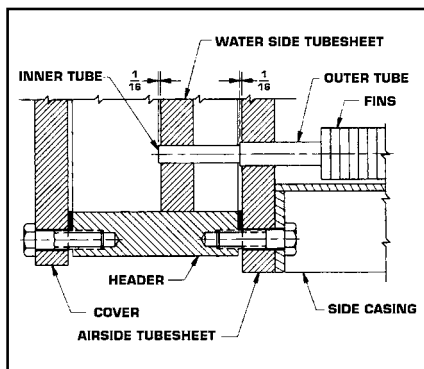

water leak into the cooling air, which dissipates the heat by sensing moisture before it can leak into the air.

The Unifin leak detector system consists of two

bonded concentric tubes, each joined to a separate tube sheet.

This double tube construction provides double protection against possible leaks due to corrosion as well as tube barriers separating the tube side fluid and the air side.

Removable Cover Plate Coolers

Unifin manufactures a wide range of RCP generator coolers, motor coolers and marine coolers with a unique optional leak detector feature for totally enclosed water air-cooled (TEWAC) applications.

All have been developed as heavy duty industrial quality cooling coils as distinct from lightweight ventilating or air-conditioning units. Although standardized in basic designs, they can be made with optional features and materials to suit exact customer requirements.



Platefin Coolers

Unifin offers a high quality platefin technology as a premier heat transfer surface for all of our utility and industrial applications. The platefin surface offers the benefit of providing higher energy transfer efficiency and improved heat transfer in a more compact, economical and robust design.

The Unifin platefin technology uses aluminum or copper fins with full collars. The collars are engineered to provide fixed and permanent fin spacing. The collars also transfer the heat between the tubes and the fins, allowing constant performance through the full range of thermal expansion. Other tube materials such as copper, copper-nickel, stainless steel and other specialty materials are available. The tubes are mechanically expanded into the fin collars, forming an interference fit between the fin collar and the tube that effectively facilitates heat transfer.

The Unifin platefin technology is well suited for any application that requires resistance against vibrations (shorter unsupported tube length) and high mechanical stress conditions.

Cooler Services

Running Hot? Leaks? Thinking of Upgrading/Upgrading Your Generator? Unifin is Ready to Help With Wide Ranging Service Choices

The average cooler today is over 30 years old. Whether your coolers need cleaning, repair, parts, reconditioning, retubing or replacement – or if you're not even sure – Unifin has just the right solution for you.

Clean / Test / Inspect (CTI) Diagnostic Service

Corrosion and the resistance of heat transfer caused by fouling in heat exchangers are the main reasons for an increase in energy, operating and maintenance costs of a generator. That's why coolers must be inspected, cleaned and tested on a regular basis. Our standard CTI Service includes a hydrostatic test of the coolers in the received condition (to identify any leaks), power washing, gasket replacement when applicable, and written initial and final test reports.



Regardless of initial test results, the water boxes are removed for evaluation. At that point Unifin issues a set of recommendations and work scope.

Repairs / Reconditioning

Unifin can extend the life of your coolers by repairing key elements such as water boxes and/or tubesheets when needed. After blasting we apply a polymer filler and epoxy coating.

Lead carbonate decontamination service is also available.

BEFORE



AFTER

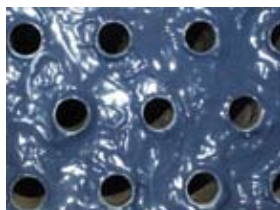

Retubing

When plugging or re-rolling leaking tubes won't suffice, Unifin can replace the existing tubes. This allows for continued use of the original frames, water boxes and tubesheets depending on the overall cooler condition.

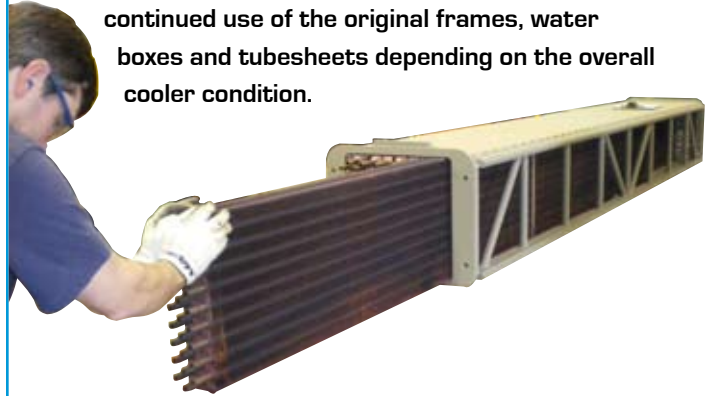

Upgrades / Upgrades

Vintage spiral fin cooler designs often contain lead-based solder which over time, could result in lead carbonate contamination throughout the entire hydrogen-cooled generator system. Platefin designs do not. Unifin offers spiral fin to platefin redesign replacement solutions to eliminate this potential issue while restarting your cooler life cycle. Our other upgrades also include material substitutions for improved performance.

If a generator uprate (i.e. rewind) is contemplated, Unifin offers cooler studies to determine appropriate course of action to support proposed system uprate scenarios.

SPIRAL FIN



PLATEFIN



Replacements / Redesigns

Cooler replacement is recommended for more serious conditions including plugged/corroded tubes, degraded tubesheets and/or waterboxes. Unifin can provide brand new in-kind replacements designed to be physically interchangeable in form, fit and thermal function with the originals. Our archives often contain the original design drawings for existing coolers, allowing us to do this sight unseen. This saves the time and expense of sending us the original coolers in advance for estimating purposes.

The average age of hydrogen coolers at time of replacement is 27 years, with 35 years for air type coolers.

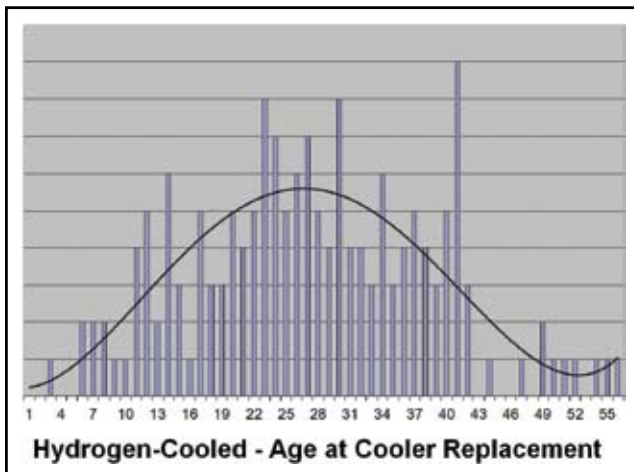

With nearly 100 years of archived engineering drawing history we have the expertise and engineering knowledge to replace or repair nearly any cooler. Our experience spans a wide range of original equipment manufacturer (OEM) designs including, among others:

- General Electric
- Westinghouse
- Griscom Russel
- Andal
- Schutte & Koerting
- Perfex
- Basco
- Baldwin Lema Hamilton
- Ross
- Trane
- Harrison
- Doyle & Roth
- Parsons Peebles

Spare Parts

For all of Unifin's Generator Cooler Products

Here is the answer to keep things cool. Unifin stands ready to assist you with all of your Spare Parts needs:

- Gaskets
- O-Rings
- Water Boxes/Covers
- Customized Replacement Parts
- Cooler Subassemblies

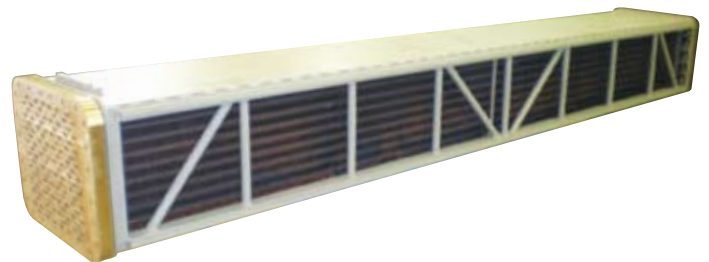

Whatever replacement solutions you require, simply contact us for assistance with part identification and availability. Same-day and 24 hour shipment are available on selected items.

Spare Parts Hotlines:

Generator Coolers

Tel: (757) 485-2666 Ext 229

Transformer & Motor Coolers

Tel: (519) 451-0310 Ext 100

A World Leader

Who We Are

Service...Speed...Dependability

At Unifin the cooling of Electric Machines is our only business. Every resource in the company has been directed towards research and development to acquire world leading heat transfer technology and manufacturing processes. Today, this investment has established Unifin as a global leader in the supply of:

- Transformer Oil Coolers
- Transformer Oil Pumps
- Generator Coolers
- TEWAC Motor Coolers

Global Presence

Headquartered in London, Ontario, Canada, Unifin is a global organization with manufacturing locations in Canada, the United States and China.

Our Brands

Unifin is a global company with worldwide recognized brands in transformer oil coolers, transformer oil pumps, generator coolers and TEWAC motor coolers.

- **ForZair™** transformer oil coolers
- **HeatSink™** portable transformer coolers
- **HARLEY™** sleeve bearings
- **TecSonics™** bearing wear monitoring system
- Formerly **GE Tidewater Heat Transfer Products™** generator coolers
- **RCP™** coolers
- **WeatherAll™** power cords



The Hottest Name in Cooling



Corporate Head Office:
1030 Clarke Road,
London, Ontario, Canada N5V 3B2
Tel: (519) 451-0310
Fax: (519) 451-1732
unifin@wabtec.com

Generator Cooler Manufacturing Plant:
2601F Trade Street,
Chesapeake, Virginia, USA 23323
Tel: (757) 485-2666
Fax: (757) 485-2688
unifin-ches@wabtec.com

www.unifin.com